



TECHNICAL DATA SHEET

VK1001 Standard Response Upright Sprinkler K5.6 (80.6)

1. PRODUCT IDENTIFICATION

This document covers the following product, hereafter referred to as “sprinkler”:

VK1001: Standard Response, Standard Coverage, Upright, K5.6 (80.6) Sprinkler.

2. INTENDED USE

The sprinkler is intended to be used in automatic fire sprinkler systems as allowed by applicable approval authorities. The sprinkler must be used in accordance with:

1. the sprinkler’s Listings, Approvals, and associated design requirements.
2. the recognized design and installations standards issued, for example NFPA, FM, EN, VdS, or LPCB.
3. the latest revisions of all applicable manufacturer’s documentation.



Governmental codes, ordinances, and standards may apply and may differ from one another.

WARNING

Cancer and Reproductive Harm www.P65Warnings.ca.gov

3. LISTING AND APPROVALS

Refer to section 5 for details and requirements that must be followed.



4. TECHNICAL SPECIFICATIONS

4.1 Definitions

Standard Upright Sprinkler: A sprinkler intended to be oriented with the deflector above the frame so water flows upward through the orifice, striking the deflector and forming an umbrella-shaped spray pattern downward. These sprinklers are marked “SSU” (Standard Spray Upright) or “UPRIGHT” on the deflector.

Corrosion-Resistant Sprinkler: A special service sprinkler with non-corrosive protective coatings, or that is fabricated from non-corrosive material, for use in atmospheres that would normally corrode sprinklers. Standard sprinklers can be ordered as corrosion resistant sprinklers and can be used with escutcheons when allowed by the approval body.

4.2 Ratings and Physical Characteristics

| Parameter | Value |
|---|------------------------|
| Minimum operating pressure | 7 psi (0.5 bar) |
| Maximum rated pressure | See section 5 |
| Factory tested pressure | 500 psi (35 bar) |
| Thread size | 1/2" NPT or 15 mm BSPT |
| Nominal K-factor | 5.6 U.S. (80.6) |
| Minimum temperature rating (glass bulb) | -65 °F (-55 °C) |

4.3 Markings and Dimensions

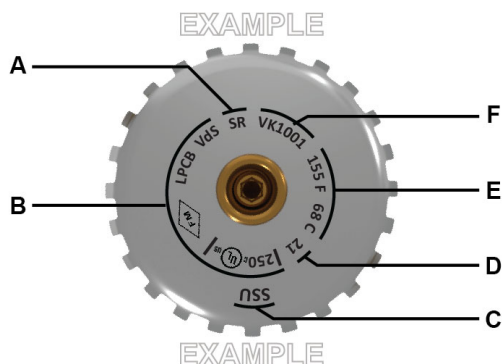

Figure – 1: Markings

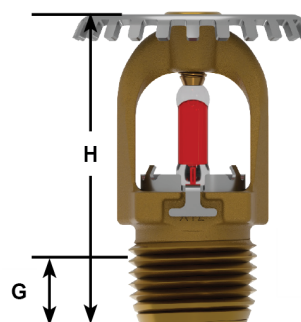

Figure – 2: Dimensions

| Ref | Description | Value |
|-----|--|-----------------------------|
| A | Response type | SR: Standard Response |
| B | Listings and Approvals | See sections 3 and 5 |
| C | Sprinkler type | SSU: Standard Spray Upright |
| D | Manufacture date (year) | See marking |
| E | Nominal temperature rating | See marking |
| F | Manufacturer's Sprinkler Identification Number (SIN) | VK1001 |
| G | Nominal pipe engagement | 7/16" (11 mm) |
| H | Height | 1 15/16" (49 mm) |

4.4 Materials of Construction

NOTICE: Do not disassemble the sprinkler.

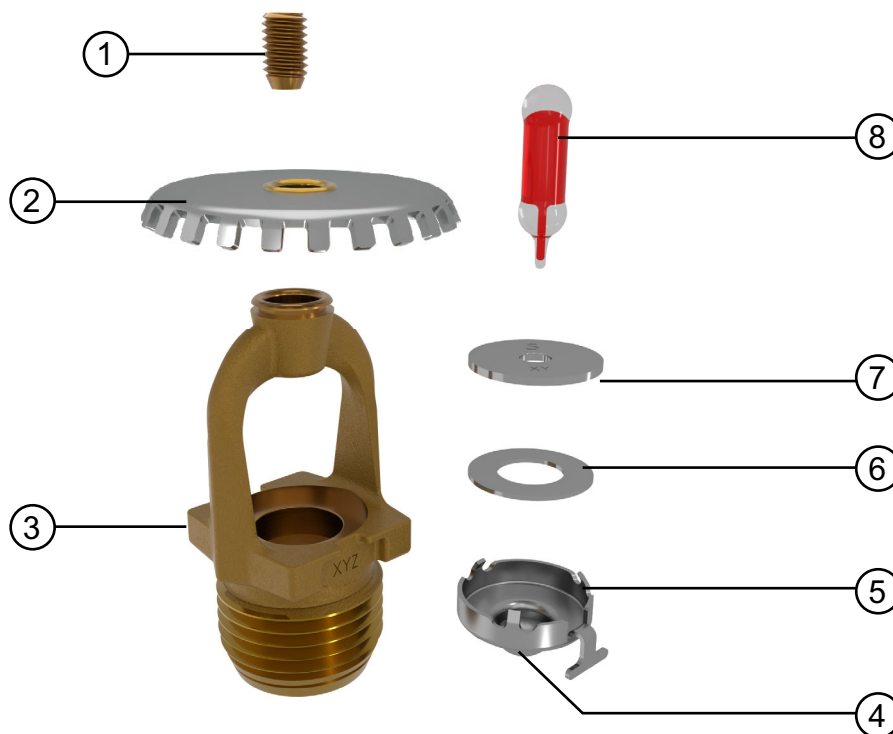

Figure – 3 Sprinkler Components

| Ref | Description | Material |
|-----|-------------------|--|
| 1 | Compression screw | Brass CW612N, CW508L, UNS-C36000 or UNS-C26000 |
| 2 | Deflector | Stainless steel UNS S30400 |
| 3 | Sprinkler body | CW602N, UNS-C84400 or QM brass |
| 4 | Pip cap seal | Polytetrafluoroethylene (PTFE) |
| 5 | Pip cap shell | Stainless steel UNS-S44400 |
| 6 | Belleville spring | Nickel alloy |
| 7 | Pip cap disc | Stainless steel UNS-S30100 |
| 8 | Bulb | Glass, nominal 0.20" (5 mm) diameter |

TECHNICAL DATA SHEET
**VK1001 Standard Response
Upright Sprinkler K5.6 (80.6)**
5. LISTING AND APPROVAL DESIGN REQUIREMENTS
5.1 Listing and Approval Specifications

| Sprinkler Base Part Number ¹ | Thread Size | | Approval Body | | | | | | | |
|---|-------------|-------|-----------------|----|-----------------|------|-----|------|-----|-------|
| | NPT | BSPT | cULus | FM | CE | LPCB | VdS | UKCA | MED | China |
| Maximum WWP PSI (bar) → | | | 250 (17) | | 175 (12) | | | | | |
| 23867 | 1/2" | — | A1 | A1 | A1 | A1 | A1 | A1 | A1 | — |
| 23879 | — | 15 mm | A1 | A1 | A1 | A1 | A1 | A1 | A1 | — |
| 26753 | — | 15 mm | B2 | B2 | — | — | — | — | — | B2 |
| Approval Specification (Temperature Ratings) Key: | | | | | | | | | | |
| A = 135 °F (57 °C), 155 °F (68 °C), 175 °F (79 °C), 200 °F (93 °C) and 286 °F (141 °C) | | | | | | | | | | |
| B = 155 °F (68 °C), 175 °F (79 °C), 200 °F (93 °C) and 286 °F (141 °C) | | | | | | | | | | |
| Approval Specification (Finishes) Key: | | | | | | | | | | |
| 1 = Brass, Chrome, White Polyester ^{2,3} , Black Polyester ^{2,3} , and ENT ^{3,4} | | | | | | | | | | |
| 2 = Chrome | | | | | | | | | | |
| 1 For complete part number, refer to Viking's current price list. | | | | | | | | | | |
| 2 For White Polyester and Black Polyester, other colors are available upon request and will carry the same Listings and Approvals as the standard colors. | | | | | | | | | | |
| 3 cULus Listed as corrosion-resistant. | | | | | | | | | | |
| 4 FM Approved as corrosion-resistant. | | | | | | | | | | |

5.2 cULus Listing Requirements and Details

The sprinkler is cULus Listed as indicated in Table 5.1 for installation in accordance with the latest edition of NFPA 13 for standard spray sprinklers. This sprinkler is designed for use in light, ordinary, and extra hazard occupancies.

5.3 FM Approval Requirements and Details

The sprinkler is FM Approved as standard response Non–Storage upright sprinkler as indicated in the FM Approval Guide. The sprinkler is also approved for use in FM Approved vacuum dry sprinkler systems with a maximum supervisory vacuum pressure of –3 psi (–207 mbar). FM Global Loss Prevention Data Sheets contain guidelines relating to, but not limited to: minimum water supply requirements, hydraulic design, ceiling slope and obstructions, minimum and maximum allowable spacing, and deflector distance below the ceiling. For specific application and installation requirements, refer to the latest applicable FM Loss Prevention Data Sheets (including Data Sheet 2–0).

5.4 Additional Approval Requirements and Details

Refer to Table 5.1 for approved configurations allowed by each of the following approvals.

- CE CPR: Standard EN 12259-1:1999 +A3:2006; Declaration of Performance DOP_VK1001.
- LPCB: Standard EN 12259-1:1999 +A3:2006; Certificate Number 096m.
- VdS: Standard EN 12259-1:1999 +A3:2006; Certificate Number G 422003.
- UKCA: Standard EN12259-1:1999 +A3:2006; Declaration of Conformity UKCA DOC_S5048.
- MED: Standard EN 12259-1:1999 +A3:2006; Declaration of Conformity DOC_MED_XT1.
- China Approval: Approved according to China GB standard.

For specific application and installation requirements, refer to the latest applicable governmental codes, ordinances, and standards for the installation location.



5.5 Corrosion-Resistant Coatings

The corrosion resistant coatings have passed the standard corrosion tests required by the approving agencies and are listed and approved as indicated in Table 5.1. These tests do not represent all possible corrosive environments. The Electro-less Nickel PTFE (ENT) finish passed the UL 199 thirty day corrosion test and is cULus listed and FM Approved as corrosion resistant. For automatic sprinklers, the ENT coating is applied to all exposed exterior surfaces, including the waterway.

Prior to installation, verify that the coatings are compatible with, or suitable for, the proposed environment. The ENT finish has not been evaluated for environments containing chlorine, such as indoor swimming pools. The ENT finish is not recommended for these applications.

5.6 Sprinkler Guards and Water Shields

The sprinkler is approved for use with the Model XG Sprinkler Guard and the Model XWU upright water shield. Refer to the Guards and Water Shields for XT1 Sprinklers technical data sheet for more information.

5.7 Available Temperature Ratings

Viking sprinklers are available in several temperature ratings that relate to a specific temperature classification. Applicable installation rules mandate the use and limitations of each temperature classification. The maximum expected ceiling temperature must be known before selecting the appropriate temperature classification.

Before ordering a sprinkler, use a maximum-reading thermometer to determine the maximum expected temperature. In addition, refer to recognized installation rules which may require a higher temperature classification to be used. The rules may depend upon the following criteria:

- sprinkler location
- occupancy classification
- commodity classification
- storage height
- other nearby hazards

In all cases, the maximum expected ceiling temperature dictates the lowest allowable temperature classification. Sprinklers located immediately adjacent to a heat source may require a higher temperature rating.

TECHNICAL DATA SHEET
**VK1001 Standard Response
Upright Sprinkler K5.6 (80.6)**
6. ORDERING PROCEDURE
6.1 Sprinkler

1. Choose a sprinkler base part number with the required thread size and listing or approval (refer to section 5):
2. Add the suffix for the desired finish.
3. Add the suffix for the desired temperature rating.

NOTE: For Polyester, insert the desired temperature rating suffix where the dash (-) is shown.

EXAMPLE: 23867MB/W = VK1001 with white polyester finish and 155 °F (68 °C) nominal temperature rating. This sprinkler is to be installed into an area with a maximum ambient temperature of 100 °F (38 °C).

| 1. Sprinkler Base Part Number | | 2. Finish | | 3. Temperature Rating | | | |
|-------------------------------|------------|-----------------|--------|----------------------------|------------|-------------------------------------|--------|
| See Section 5 | | Description | Suffix | Nominal Temperature Rating | Bulb Color | Maximum Ambient Ceiling Temperature | Suffix |
| 23867 | 1/2" NPT | Brass | A | 135 °F (57 °C) | Orange | 100 °F (38 °C) | A |
| 23879 | 15 mm BSPT | Chrome | F | 155 °F (68 °C) | Red | 100 °F (38 °C) | B |
| 26753* | 15 mm BSPT | White Polyester | M-/W | 175 °F (79 °C) | Yellow | 150 °F (65 °C) | D |
| | | Black Polyester | M-/B | 200 °F (93 °C) | Green | 150 °F (65 °C) | E |
| | | ENT | JN | 286 °F (141 °C) | Blue | 225 °F (107 °C) | G |
| | | | | OPEN | — | — | Z |

*Only for China

6.2 Sprinkler Accessories

Figure – 4: Sprinkler Accessories

| Image Reference | Part Number | Description |
|-----------------|-------------|--|
| 1) | 23559MB | Straight wrench: required for proper installation |
| 2) | 01724A | Sprinkler cabinet: holds up to 6 sprinklers |
| 3) | 01725A | Sprinkler cabinet: holds up to 12 sprinklers (not shown) |

TECHNICAL DATA SHEET
**VK1001 Standard Response
Upright Sprinkler K5.6 (80.6)**
7. CONTACT

The sprinkler and accessories are available through Viking distributors only. Contact your local Viking sales office which can be found on our website:

Americas and Asia: www.vikinggroupinc.com/locations OR Europe, Middle East, Africa (EMEA):
www.viking-emea.com/contact

Manufacturer:

The Viking Corporation
5150 Beltway SE
Caledonia, MI 49316
Tel.: (800) 968-9501
Fax: 269-818-1680
Technical Services: 1-877-384-5464
techsvcs@vikingcorp.com

Importer EU:

Viking S.A.
21, Z.I, Haneboesch
L-4562 Differdange / Niederkorn
Tel.: +352 58 37 37 - 1
Fax: +352 58 37 36
vikinglux@viking-emea.com

Asia Pacific (APAC) Main Office:

The Viking Corporation (Far East) Pte.
Ltd.
69 Tuas View Square
Westlink Techpark, Singapore 637621
Tel: (+65) 6 278 4061
Fax: (+65) 6 278 4609
vikingAPAC@vikingcorp.com



Handling and Installation Instructions

Model XT-1 Upright Sprinklers

| | | | | |
|-----------|---|--|-----------|---|
| | bg | Инсталирайте и пуснете продукта в експлоатация само ако следната инструкция е ясно разбрана. | lv | Produkta iemontēšanu un ekspluatācijas sākšanu veikt tikai tad, ja dotā instrukcija ir pilnībā saprasta. |
| | cs | Namontujte a spusťte do provozu produkt pouze tehdy, když jste jasně pochopili tento návod. | lt | Produktą montuokite ir pradėkite eksploatuoti tik tuomet, jei aiškiai suprantate šią instrukciją. |
| | de | Du må kun montere og idriftsætte produktet, hvis du har forstået følgende vejledning til fulde. | mt | Installa u f'ad dem il-prodott biss jekk l-istruzzjonijiet li ġejjin jinftiehm b'mod ċar. |
| | de | Produkt nur einbauen und in Betrieb nehmen, wenn die nachfolgende Anleitung klar verstanden wird. | nl | Product alleen installeren en in gebruik nemen, als de volgende instructies begrepen zijn. |
| | el | Η εγκατάσταση και θέση σε λειτουργία του προϊόντος επιτρέπονται μόνο εάν οι ακόλουθες οδηγίες έχουν γίνει κατανοητές. | no | Ikke installer og ta i bruk produktet uten at følgende anvisninger er tydelig forstått. |
| | en | Do not install and commission the product unless you have clearly understood the instructions below. | pl | Produkt należy montować i uruchamiać tylko wtedy, gdy poniższe instrukcje są w pełni zrozumiałe. |
| | es | Instalar el producto y ponerlo en funcionamiento solo cuando se hayan comprendido claramente las siguientes instrucciones. | pt | Instalar e colocar o produto em funcionamento somente se as instruções a seguir forem claramente compreendidas. |
| | et | Paigaldage toode ja kasutage seda ainult siis, kui saate alljärgnevast juhendist selgelt aru. | ro | Montați produsul și puneți-l în funcțiune numai dacă instrucțiunea următoare este înțeleasă clar. |
| | fi | Tuotteen saa asentaa ja ottaa käyttöön vain, jos jäljempänä oleva ohje ymmärretään selvästi. | ru | Не устанавливайте и не принимайте оборудование в эксплуатацию, если вы четко не поняли инструкции ниже |
| | fr | N'installer et ne mettre en service le produit que si les instructions suivantes ont été clairement comprises. | sk | Namontujte a spusťte do prevádzky výrobok iba vtedy, pokiaľ ste jasne pochopili tento návod. |
| | ga | Ná déan an táirge a shuiteail agus a choimisiunu mura dtuigeann tu na teoracha thíos go soileir. | sl | Izdelek vgradite in zaženite samo, če ste dobro razumeli navodila v nadaljevanju. |
| | hr | Ne instalirajte i ne puštajte proizvod u rad ako niste jasno razumjeli donje upute. | sr | Ne instalirajte i ne puštajte proizvod u rad ako niste jasno razumeli uputstva u nastavku. |
| | hu | Csak akkor építse be a terméket és helyezze üzembe, ha a következő útmutatót egyértelműen megértette. | sv | Montera och driftsätt produkten endast om du förstår den efterföljande instruktionen. |
| | is | Settu ekki upp eða taktu vöruna í notkun nema þú hafir skilið greinilega leiðbeiningarnar hér að neðan. | tr | Aşağıdaki talimatları açıkça anlamadan ürünü kurmayın ve devreye almayın. |
| it | Montare il prodotto e metterlo in funzione solo se si sono comprese appieno le seguenti istruzioni. | | | |

1. PRODUCT IDENTIFICATION

This document covers the following products, hereafter referred to as “sprinkler”:

- VK1001 Standard Response Upright Sprinkler K5.6 (80.6)
- VK2001 Standard Response Upright Sprinkler K8.0 (115)
- VK2002 Standard Response Upright Sprinkler K8.0 (115)
- VK3001 Quick Response Upright Sprinkler K5.6 (80.6)
- VK3501 Quick Response Upright Sprinkler K8.0 (115)
- VK3502 Quick Response Upright Sprinkler K8.0 (115)
- OTHER APPLICABLE DOCUMENTS

2. OTHER APPLICABLE DOCUMENTS

For intended use and relevant conditions for the safe use of the specific sprinkler refer to the appropriate *Technical Data Sheet*.



Handling and Installation Instructions

Model XT-1 Upright Sprinklers

3. TRANSPORT AND HANDLING

WARNING

A damaged or compromised sprinkler poses the risk of fatal consequences.

Damaged or compromised sprinklers will not operate properly which could lead to loss of life.

- NEVER use a sprinkler that has been exposed to temperatures exceeding the maximum allowed ambient temperature.
- NEVER use a sprinkler with a loss of liquid from the glass bulb or damage to the fusible element. A small bubble should be visible within the glass bulb; rotate the sprinkler to a horizontal position while observing the bulb to see the bubble.
- NEVER use a sprinkler that has been dropped or damaged.
- ALWAYS Protect the sprinkler from mechanical damage during storage, transport, and handling.
- NEVER use sprinklers that have been painted by anyone other than the manufacturer.
- ALWAYS protect sprinklers from being painted during installation or replacement in accordance with the installation standards.
- NEVER clean sprinklers with anything other than 7 psi or lower compressed air.
- NEVER apply soap, water, ammonia, adhesives, solvents or any other fluids on sprinklers.
- Destroy every damaged or compromised sprinkler.

NOTICE

Protect sprinklers during transport and handling.

- ALWAYS handle the sprinkler with care.
- ALWAYS keep the protective cap on the sprinkler during transport and handling.
- NEVER remove the protective cap until the fire sprinkler system is placed in service and the potential for mechanical damage no longer exists.
- ALWAYS protect the sprinkler from direct sunlight during transport and handling.
- ALWAYS store sprinkler in a cool, dry, protected area.
- ALWAYS use original manufacturer's shipping containers.
- NEVER store a sprinkler loose in a box, bin, bucket, or other type of container.
- ALWAYS keep the sprinkler separated from other sprinklers.
- NEVER allow metal parts to contact the sprinkler operating elements.

NOTE: If the glass bulb included on the sprinkler has been exposed to ultraviolet light, the color inside the bulb may fade. This color change does not affect the operation of the sprinkler.

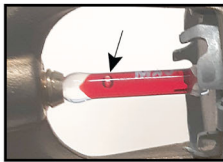

CORRECT
(Bulb intact, bubble visible)



INCORRECT
(bulb cracked, fluid missing)



CORRECT
(Protective caps in place)



INCORRECT
(Protective caps not in place)



CORRECT
Container



INCORRECT
(Stored loose in a box)



4. INSTALLATION

⚠ WARNING

Installation by insufficiently qualified personnel poses the risk of fatal consequences.

- This sprinkler must be installed properly by qualified personnel familiar with safe practices and applicable and recognized design and installation standards issued, for example, by NFPA, FM, VdS, or LPCB, and trained how to properly perform the installation procedures.

⚠ CAUTION

Cutting Hazard.

Sprinklers, accessories, cabinets, and packaging can have sharp edges that can cause cuts.

- Wear appropriate personal protective equipment (gloves) while handling product.

Optional Guards, Shields, and Escutcheons: If the sprinkler shall be installed together with a guard, shield, or escutcheon refer to the applicable documents for the products used.

1. Install all required piping in the intended installation location.
2. Verify that the sprinkler model/style, K-factor, temperature rating, and response characteristics are appropriate for the intended installation location. See Table 1 and Figure 4.
3. Inspect the sprinkler for damage. Destroy every damaged or compromised sprinkler. The following are examples in which sprinklers are considered damaged or compromised. Replace the sprinkler in the following cases:
 - Sprinkler with a loss of fluid from the glass bulb or damage to the fusible element.
 - Sprinklers that have been field painted, caulked, or mechanically damaged.
 - Sprinklers showing signs of corrosion.
4. Verify that the sprinkler is protected with the protective cap or clip.
5. Apply a small amount of pipe-joint compound or tape to the external threads of the sprinkler only. Do not allow a build-up of compound inside the sprinkler inlet (Figure 1).

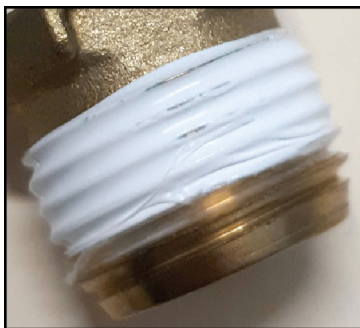

Figure – 1

6. **NOTICE: Do not use the deflector to start threading the sprinkler into a fitting. Use ONLY the approved wrench to install the sprinkler. Refer to the sprinkler’s *Technical Data Sheet*.**

Carefully slide the proper wrench onto the wrench flats (Figure 2).

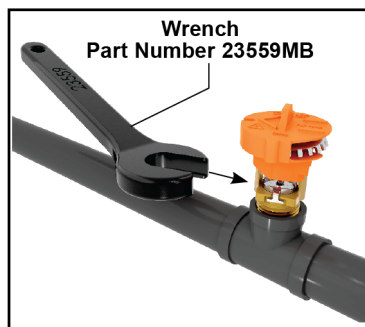

Figure – 2

7. **NOTICE: Over-tightening the sprinkler can cause permanent damage. For 1/2" NPT (or 15 mm BSPT) sprinkler, tighten up to a maximum torque of 14 ft-lbs (19 Nm). For 3/4" NPT (or 20 mm BSPT) sprinkler, tighten up to a maximum of 20 ft-lbs (27,1 Nm).**

Tighten the sprinkler as necessary (Figure 3). If applicable, install a sprinkler guard and water shield.

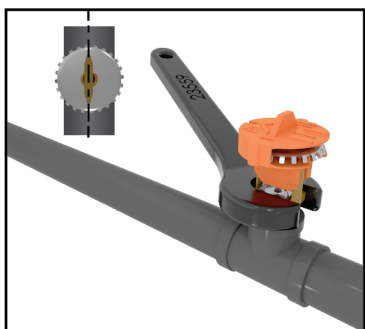

Figure – 3

8. **NOTICE: Sprinkler protective caps/clips must be removed from the sprinkler before placing the system in service. Test the entire sprinkler system.**

Refer to the applicable system documentation, regulations, and standards to ensure compliance.

| Table 1: Sprinkler Markings | |
|-----------------------------|--|
| Ref | Parameter |
| A | Response type |
| B | Listings and approvals |
| C | Sprinkler type |
| D | Manufacture date |
| E | Nominal temperature rating |
| F | Manufacturer’s Sprinkler Identification Number (SIN) |

EXAMPLE
Figure – 4



Handling and Installation Instructions

Model XT-1 Upright Sprinklers

5. CONTACT

The sprinkler and accessories are available through Viking distributors only. Contact your local Viking sales office which can be found on our website:

Americas and Asia: www.vikinggroupinc.com/locations OR Europe, Middle East, Africa (EMEA): www.viking-emea.com/contact

Manufacturer:

The Viking Corporation
5150 Beltway SE
Caledonia, MI 49316
Tel.: (800) 968-9501
Fax: 269-818-1680
Technical Services: 1-877-384-5464
techsvcs@vikingcorp.com

Importer EU:

Viking S.A.
21, Z.I, Haneboesch
L-4562 Differdange / Niederkorn
Tel.: +352 58 37 37 – 1
Fax: +352 58 37 36
vikinglux@viking-emea.com

Asia Pacific (APAC) Main Office:

The Viking Corporation (Far East) Pte. Ltd.
69 Tuas View Square
Westlink Techpark, Singapore 637621
Tel: (+65) 6 278 4061
Fax: (+65) 6 278 4609
vikingAPAC@vikingcorp.com



1. PRODUCT IDENTIFICATION

This document covers the following product, hereafter referred to as “sprinkler” (SR=Standard Response, QR=Quick Response):

- VK1001 SR Upright Sprinkler K5.6 (80.6)
- VK2001 SR Upright Sprinkler K8.0 (115)
- VK2002 SR Upright Sprinkler K8.0 (115)
- VK3001 QR Upright Sprinkler K5.6 (80.6)
- VK3501 QR Upright Sprinkler K8.0 (115)
- VK3502 QR Upright Sprinkler K8.0 (115)
- VK1021 SR Pendent Sprinkler K5.6 (80.6)
- VK2021 SR Pendent Sprinkler K8.0 (115)
- VK2022 SR Pendent Sprinkler K8.0 (115)
- VK3021 QR Pendent Sprinkler K5.6 (80.6)
- VK3521 QR Pendent Sprinkler K8.0 (115)
- VK3522 QR Pendent Sprinkler K8.0 (115)
- VK1181 SR Conventional Sprinkler K5.6 (80.6)
- VK1201 SR Conventional Sprinkler K8.0 (115)
- VK1202 SR Conventional Sprinkler K8.0 (115)
- VK3101 QR Conventional Sprinkler K5.6 (80.6)
- VK3541 QR Conventional Sprinkler K8.0 (115)
- VK3542 QR Conventional Sprinkler K8.0 (115)

WARNING

Cancer and Reproductive Harm www.P65Warning.ca.gov

2. OTHER APPLICABLE DOCUMENTS

For intended use and relevant conditions for the safe use of the specific sprinkler, refer to the appropriate Technical Data Sheet. In case an installed sprinkler needs to be replaced, refer to the appropriate Handling and Installation Instructions for the installation of the new sprinkler.

3. MAINTAINING OPERATIONAL READINESS

Functionality

During fire conditions, the operating element fuses or shatters (depending on the type of sprinkler), releasing the pip cap and sealing assembly. Water flowing through the sprinkler orifice strikes the sprinkler deflector, forming a uniform spray pattern to control or extinguish the fire.

WARNING

This section contains important safety information. Read and follow all information.

Damaged or Compromised Sprinklers

Damaged or compromised sprinklers will not operate properly which could lead to loss of life.

- NEVER clean, paint, or caulk sprinklers.
- NEVER apply soap, water, ammonia, adhesives, solvents or any other fluids on sprinklers.
- NEVER expose sprinklers to temperatures exceeding the maximum allowed ambient ceiling temperature. See the Technical Data Sheet.
- ALWAYS replace a compromised or damaged sprinkler.
- NEVER attempt to repair or reassemble a sprinkler.
- ALWAYS replace operated sprinklers and cover assemblies and sprinklers exposed to corrosive products of combustion.
- Replacement of sprinklers must only be performed following the instructions in section 4.

The following are examples in which sprinklers are considered damaged or compromised. Replace the sprinkler in the following cases:

- Sprinkler with a loss of fluid from the glass bulb or damage to the fusible element.
- Sprinklers or cover plate assemblies that have been field painted, caulked, or mechanically damaged.
- Sprinklers showing signs of extraordinary corrosion.



Obstructions and obstacles

Obstructions and obstacles may compromise sprinkler discharge patterns which are critical for proper fire protection.

- NEVER attach items to sprinklers or hang items from the ceiling in an area protected with sprinklers.
- NEVER install walls in areas protected with sprinklers without having a specialized company verifying the design of the sprinkler system.
- ALWAYS remove obstructions and obstacles to sprinkler spray patterns.

Sprinkler systems that have been subjected to a fire

Sprinkler systems that have been subjected to a fire must be returned to service as soon as possible.

- After an event of fire, the entire sprinkler system must be inspected for damage and repaired as necessary.
- Refer to the minimum requirements of the Authority Having Jurisdiction for replacement of sprinklers.
- Consider the employment of a fire patrol as long as the sprinkler system is out of service.

Inspections and testing

The owner is responsible for having the sprinklers inspected and tested according to standards of the applicable approval body and to the requirements of the Authority Having Jurisdiction to maintain proper operating condition of the system.

- Sprinklers must be inspected on a regular basis for corrosion, mechanical damage, obstructions, paint, etc. Frequency of inspections may vary due to corrosive atmospheres, water supplies, and activity around the sprinkler.

The applicable approval body or Authority Having Jurisdiction may require sprinklers to be replaced after a specified term of service.

- Refer to the standards of the applicable approval body, such as NFPA, FM, VdS, or LPCB, and the requirements of the Authority Having Jurisdiction for detailed inspection, testing and replacements requirements.

Sprinklers removed from the system for testing or for any other purpose must be replaced according to section 4.

4. REMOVAL AND REPLACEMENT

WARNING

Removal and replacement of sprinklers by insufficiently qualified personnel poses the risk of fatal consequences in case of fire.

- Removal or replacement of sprinklers must be performed by qualified personnel familiar with safe practices and applicable and recognized design and installation standards issued, for example, by NFPA, FM, VdS, or LPCB, and trained how to properly perform the installation procedures.

WARNING

Removal and replacement of sprinklers will temporarily eliminate the fire protection capabilities of the sprinkler system.

- Consider the employment of a fire patrol in the affected area.
- Prior to proceeding, notify all Authorities Having Jurisdiction.

⚠ WARNING

Re-installation of a removed sprinkler may compromise the operational safety of the sprinkler system.

- NEVER reinstall a removed sprinkler.
 - ALWAYS use new sprinklers for replacement.
1. Select new sprinklers with identical performance characteristics as well as respective accessories such as escutcheons, cover plates, and protective caps. A stocked spare sprinkler cabinet may be provided for this purpose on site.
 2. According to appropriate system description and/or valve instructions, remove the system from service, drain all water, and relieve all pressure on the piping.
 3. Only for flush and concealed style sprinklers: Remove the ceiling ring or cover plate assembly of the old sprinkler by gently unthreading or pulling it off the sprinkler body (depends on the sprinkler model used).
 4. Use the proper sprinkler wrench for the old sprinkler according to its Technical Data Sheet.
 5. Only for flush and concealed style sprinklers, but not for domed concealed sprinklers: Replace the plastic protective cap over the old sprinkler and fit the wrench over the cap.
 6. Use the wrench to remove the old sprinkler by turning it counterclockwise to unthread it from the piping.
 7. Install the new sprinkler by following its Handling and Installation Instructions.
 8. Place the system back in service and secure all valves.
 9. Check for and repair all leaks.

5. DISPOSAL

At end of use the product described here should be disposed of via the national recycling system.

6. CONTACT

The sprinkler and accessories are available through Viking distributors only. Contact your local Viking sales office which can be found on our website:

Americas and Asia: www.vikinggroupinc.com/locations OR Europe, Middle East, Africa (EMEA): www.viking-emea.com/contact

Manufacturer:

The Viking Corporation
5150 Beltway SE
Caledonia, MI 49316
Tel.: (800) 968-9501
Fax: 269-818-1680
Technical Services: 1-877-384-5464
techsvcs@vikingcorp.com

Importer EU:

Viking S.A.
21, Z.I, Haneboesch
L-4562 Differdange / Niederkorn
Tel.: +352 58 37 37 – 1
Fax: +352 58 37 36
vikinglux@viking-emea.com

Asia Pacific (APAC) Main Office:

The Viking Corporation (Far East) Pte. Ltd.
69 Tuas View Square
Westlink Techpark, Singapore 637621
Tel: (+65) 6 278 4061
Fax: (+65) 6 278 4609
vikingAPAC@vikingcorp.com